

Axialkolben-Verstellpumpe offener Kreislauf

K3V 112 DTP

Nenngrösse 112

Verdrängungsvolumen	112 cm ³ /U
Drehzahl	2700 min ⁻¹
Drehmoment bei 300 bar	588 Nm
Masse	125 kg

Drehrichtung

Rechts

Triebwelle

Zahnwelle 14 Zähne 16/32 DP

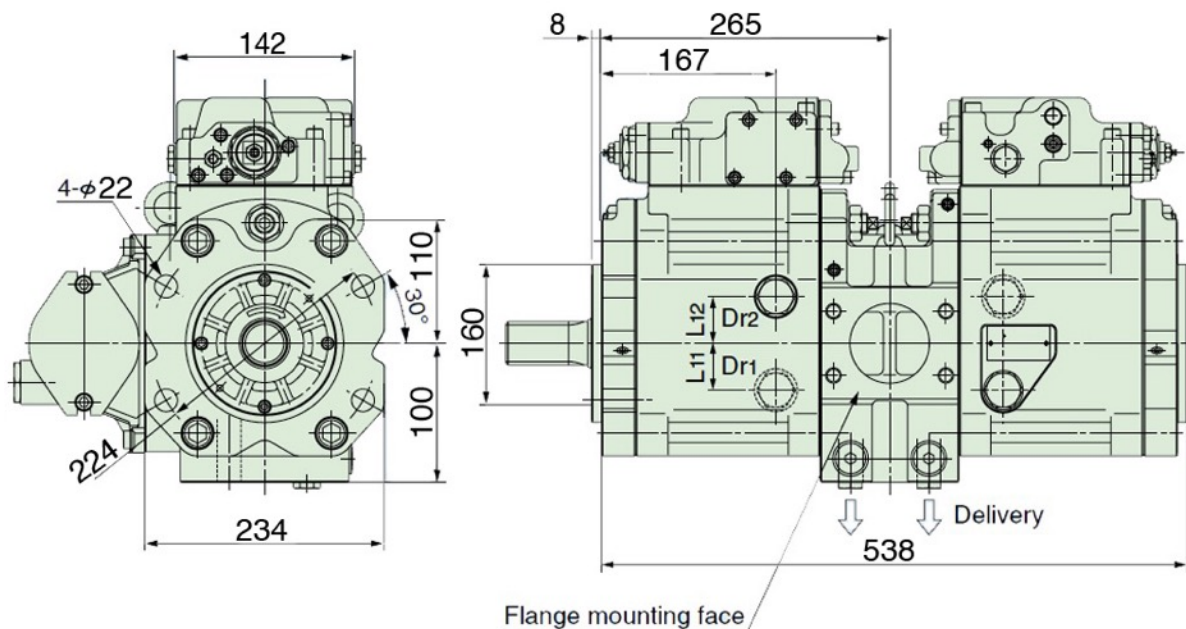

Durchtrieb

SAE-A \varnothing 82.5 mm, 10 Zähne 16/32 DP

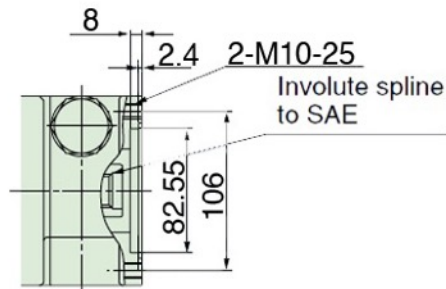

•Involute spline to SAE

Number of teeth		10	13
Cutter	Root form	Flat root	
	Diametral pitch	16/32	
	Pressure angle	30°	
Type of fit		Side fit	
Rule		SAE	